

Klettergarten Oberau

"Henga Stoa"



April 1994

Übersichtsplan

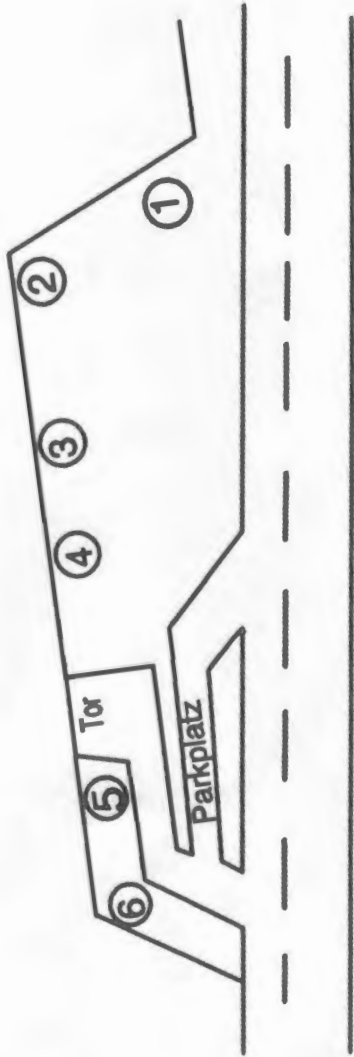

Sektor 1

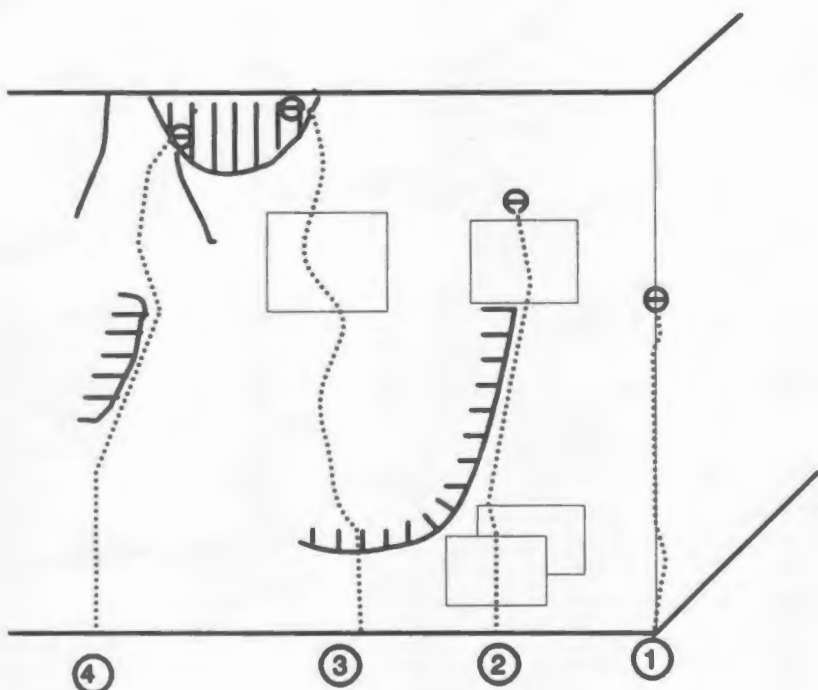

- 1 Asphalt Cowboy 9+
- 2 Ruck Zuck 8-
- 3 Streckbank 7+ / 8-
- 4 Ohne Mampf kein Kampf 7-

Sektor 2

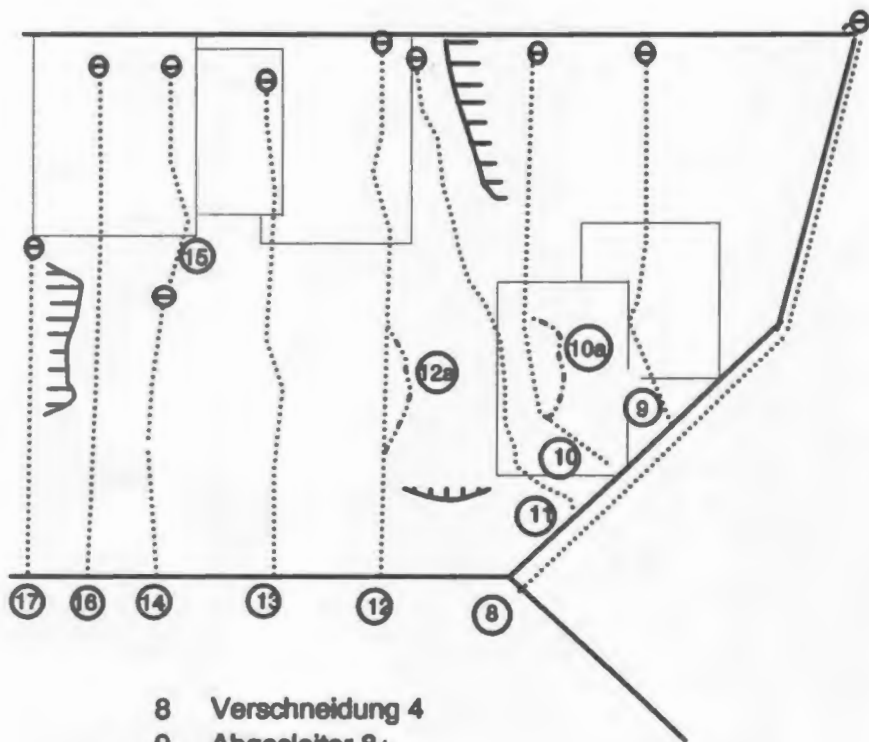

- 8 Verschneidung 4
- 9 Abgasleiter 8+
- 10 Turbolader 7+
- 10a Variante 7-
- 11 Projekt
- 12 Türkischer Honig 8- (30m)
- 12a Variante 7-/7
- 13 Szenenwechsel 7+/8-
- 14 Erdnußflip 10-
- 15 Rutschpartie 8-/8
- 16 Aufschlag 7+
- 17 Mückrig 9-

Sektor 3

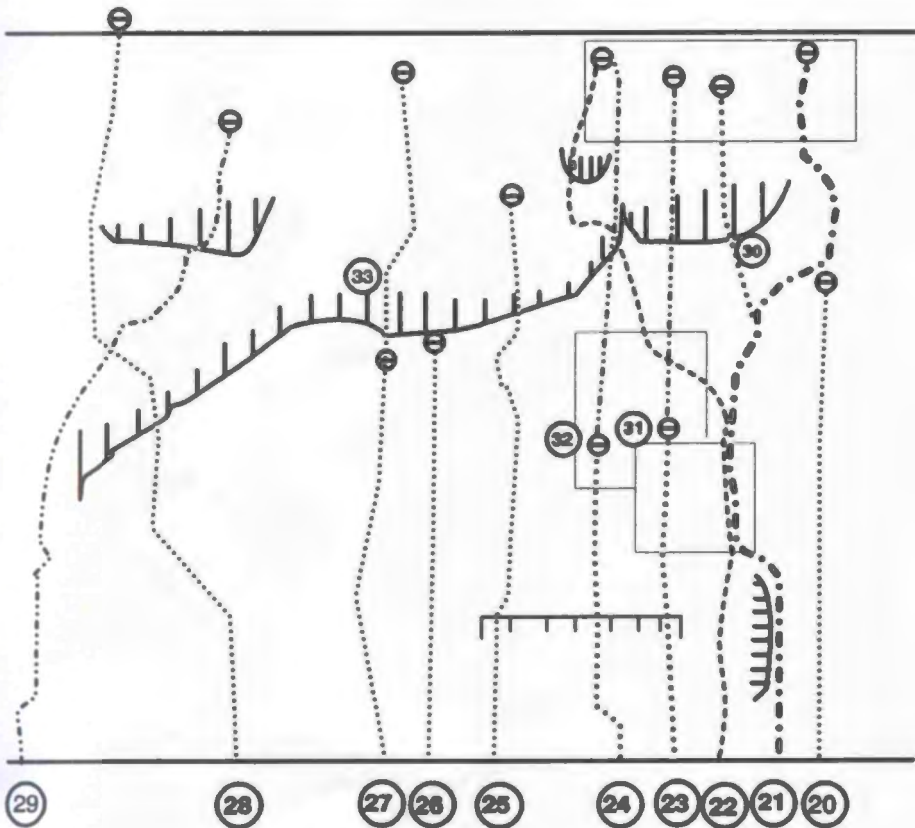

- 20 Katalysator 9/9+
- 21 Alexis 7-
- 22 Kraftmaschine 8+/9-
- 23 Weißer Streifen 9-/9
- 24 Vom Pech verfolgt 9+
- 25 Problem 9+/10-
- 26 Photon 10-

- 27 Aquaplaning 9-
- 28 Projekt
- 29 Projekt
- 30 Projekt
- 31 Projekt
- 32 Stauberater 9-
- 33 Projekt

Sektor 4

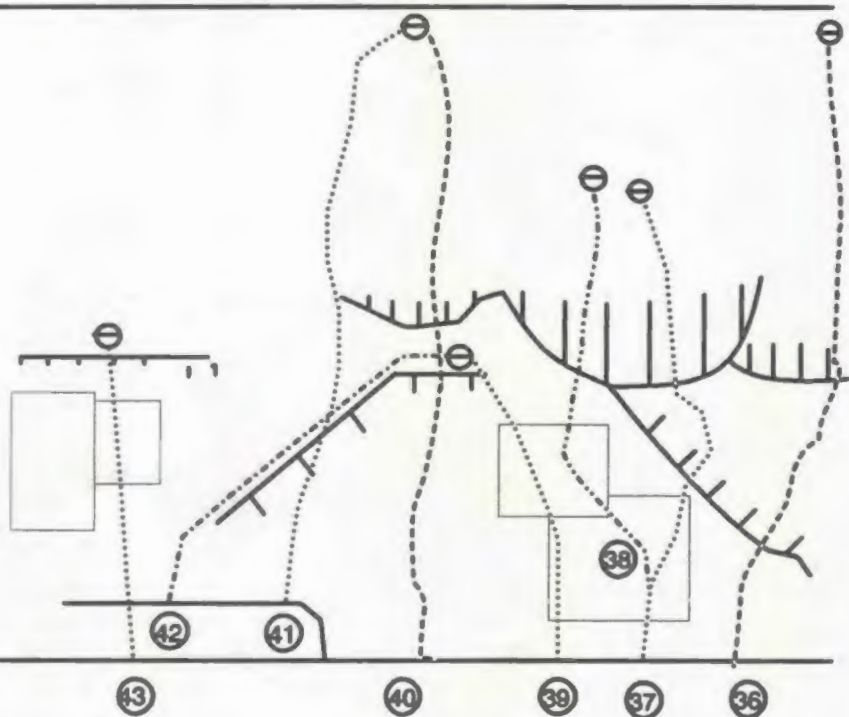

- 36 Projekt
- 37 Tears for Fears 9
- 38 König Alkohol 9
- 39 Spartanischer Genuß 7-77
- 40 Sekt oder Selters 9-
- 41 Scheißesammler 8
- 42 Rampe 5
- 43 Peanuts 7

Sektor 5

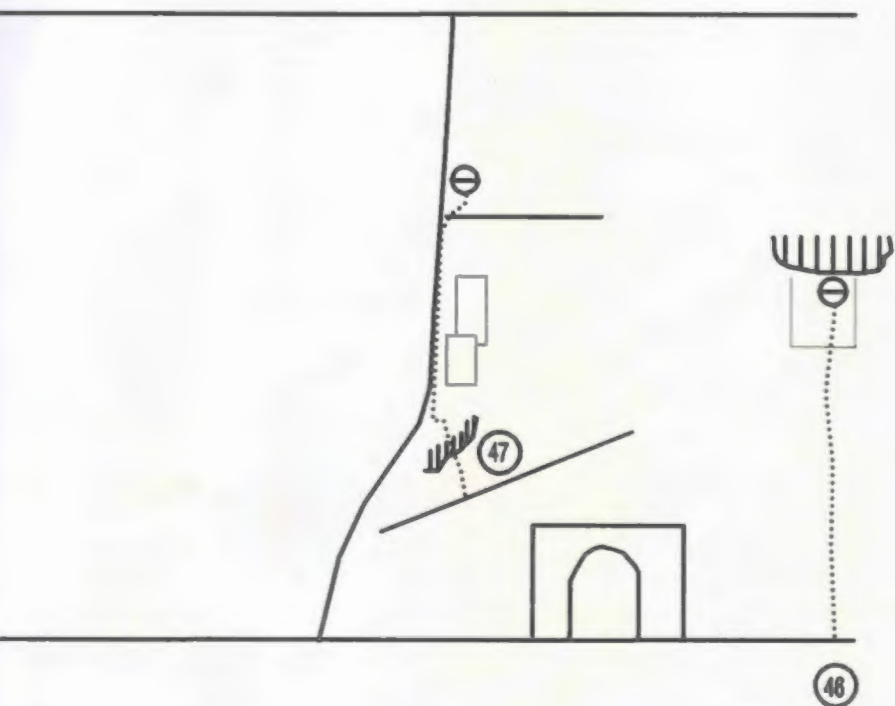

46 Bergwachtroute 4+

47 Kamin 5-

Sektor 6

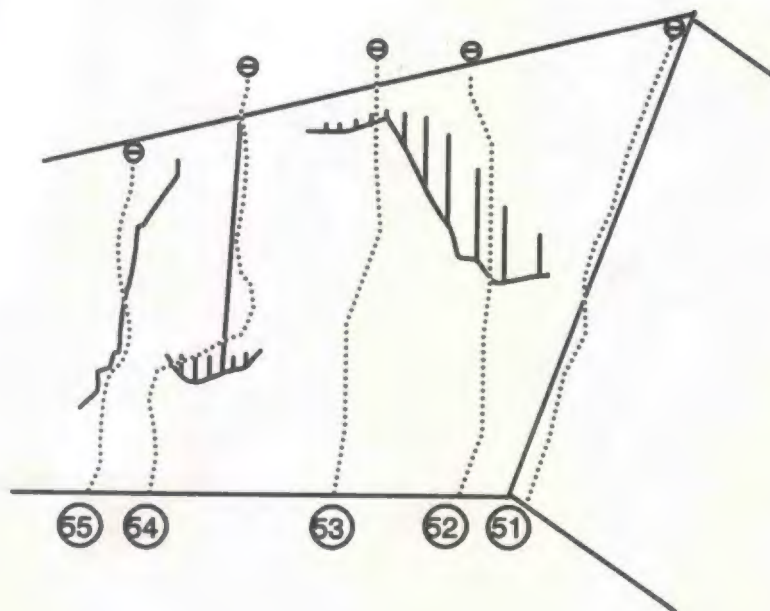

- 51 Projekt
- 52 Projekt
- 53 Projekt
- 54 Projekt
- 55 Projekt